

DA-1100

Intel® Pentium® N4200 / Celeron® N3350 Processor
Affordable Fanless Embedded Computer



- Onboard Intel® Pentium® N4200 / Celeron® N3350 Processor
- Supports Triple Independent Display
- Supports PoE+ Function (with optional CFM module)
- Supports CMI Interface for I/O Expandability
- 1x 2.5" SATA Drive Bay, 1x mSATA Socket
- 2x Full Size Mini-PCIe Socket, 1x SIM Card Socket
- Ultra Compact Size (150 x 105 x 52.3 mm)
- Wide Operating Temperature -40°C to 70°C
- Safety: UL, cUL, CB, IEC/EN62368-1

Overview

Cincoze' DA-1100 affordable fanless embedded computer is based on the Intel® Pentium® N4200 / Celeron® N3350 processor. This mainstream Intel® SoC (Apollo Lake) integrates the Intel® Gen 9 graphics architecture with triple display support in 4K/2K UHD resolution. DA-1100 supports both Combined Multiple I/O (CMI) and Control Function Module (CFM) which are specially designed for flexible I/O and function expandabilities, such as COM ports, optical isolated digital I/O, LPT/PS2, HDMI, DisplayPort, DVI-D, VGA, and Power over Ethernet (PoE).

Leveraging a reliable fanless and durable cable-free design in an ultra-compact aluminum housing, DA-1100 is ideally for deployment in space-constrained place and continuous operation under harsh environments.

Highlights



Ultra Compact & Powerful

DA-1100 is powered by Intel Apollo Lake SoC (up to 4 core, 2.5 GHz) and constructed with a palm-sized aluminum housing. It can be easily installed into a control cabinet or any other space-limited environments.



Triple Displays

DA-1100 offers enhanced graphics performance to enable three simultaneous displays and support 4K/2K UHD resolution. The third display output can be added via CMI module and is available with VGA, DisplayPort, HDMI, or DVI-D.



Power over Ethernet

By utilizing optional Cincoze Control Function Module (CFM), the system can add power over ethernet (PoE+) function with up to 25.5W per port. It is ideal for applications like machine vision or video surveillance.

Specifications

Processor

- Onboard Intel® Pentium® N4200 Quad Core Processor, up to 2.50 GHz
- Onboard Intel® Celeron® N3350 Dual Core Processor, up to 2.40 GHz

BIOS

- AMI BIOS, 8MB SPI Flash ROM built on board

Memory

- 1x DDR3L 1333/1600/1866 MHz SO-DIMM Sockets
- Supports Un-buffered and Non-ECC Type Up to 8 GB

Graphics

- Integrated Intel® HD Graphics 505 (Pentium® N4200)
- Integrated Intel® HD Graphics 500 (Celeron® N3350)
- Supports Triple Independent Display
(DVI-D + VGA from DVI-I, one output from optional CMI module)

Audio Codec

- Realtek ALC888-GR

External I/O Interface

- 1x DVI-I (1920 x 1080 @60Hz)
- 2x GbE LAN (Supports WoL, Teaming, Jumbo Frame & PXE), RJ45
 - GbE1: Intel® I210
 - GbE2: Intel® I210
- 4x USB3.2 Gen1 (Type A)
- 1x USB 2.0 (Type A)
- 2x RS-232/422/485 with Auto Flow Control, DB9
- 1x Line-out & 1x Mic-in, Phone Jack 3.5mm
- 1x ATX Power On/Off Button
- 1x AT/ATX Mode Switch
- 1x Clear CMOS Switch
- 1x Remote Power On/Off Connector, 2-pin Terminal Block

Storage

- 1x mSATA (SATA 3.0, Shared by Mini-PCIe Socket)
- 1x 2.5" HDD/SSD or 1x Half-Slim SSD (SATA 3.0)
 - * The 2.5" HDD/SSD bracket has to be removed when installing Mini-PCIe MEC LAN Module or Half Slim SSD.

Expansion

- 2x Full-size Mini-PCIe Socket
- 1x Control Function Module (CFM) Interface
- 1x Combined Multiple I/O (CMI) Interface
- 1x SIM Card Socket
- 2x Antenna Holes

Other Functions

- Watchdog Timer: Software Programmable Supports 256 Levels System Reset
- Supports Instant Reboot Technology (0.2 sec)

Power Requirement

- Supports AT/ATX Power Type
- Power Input Voltage 9~48VDC
- 1x 3-pin Terminal Block
- Power Adapter AC/DC 12V/5A 60W or 24V/5A 120W (Optional)

Physical

- Dimensions (WxDxH, mm): 150 x 105 x 52.3 mm
- Weight: 0.87 kg
- Construction: Extruded Aluminum with Heavy Duty Metal
- Mounting: Wall / VESA (Optional DIN-Rail/Side Mounting)
- Unibody Chassis
- Fanless Design
- Jumper-less Design
- Cable-less Design

Protection

- Reverse Power Input Protection
- Over Voltage Protection:
 - Protection Range: 51~58V
 - Protection Type: shut down operating voltage, re-power on at the preset level to recover
- Over Current Protection: 20A
- ESD Protection: +/-8kV (air), +/-4kV (contact)
- Surge Protection: 2 kV

Operating System

- Windows® 10
- Linux: Supports by project

Environment

- Operating Temperature: -40°C to 70°C
 - * With extended temperature peripherals; Ambient with air flow
 - * According to IEC60068-2-1, IEC60068-2-2, IEC60068-2-14
- Storage Temperature: -40°C to 85°C
- Relative Humidity: 95%RH @ 70°C (non-Condensing)
- Shock: Operating, 50 Grms, Half-sine 11 ms Duration
 - * w/ SSD, according to IEC60068-2-27
- Vibration: Operating, 5 Grms, 5-500 Hz, 3 Axes
 - * w/ SSD, according to IEC60068-2-64
- MTBF: 632,353 Hours

Certification

- EMC: CE, UKCA, FCC, ICES-003 Class A
- Safety: UL, cUL, CB, IEC/EN62368-1

External Layout

Front I/O

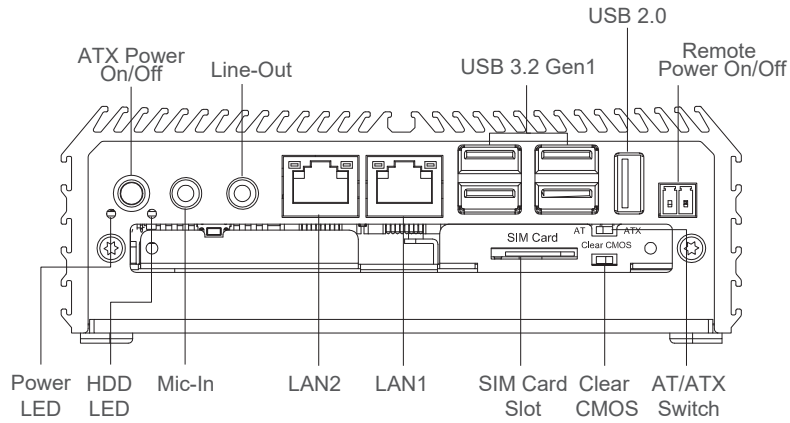

Rear I/O

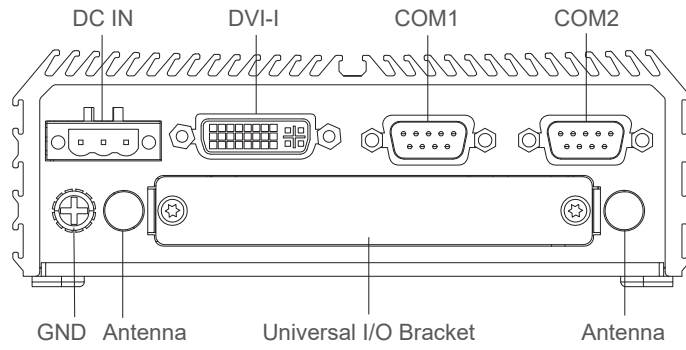

Dimensions

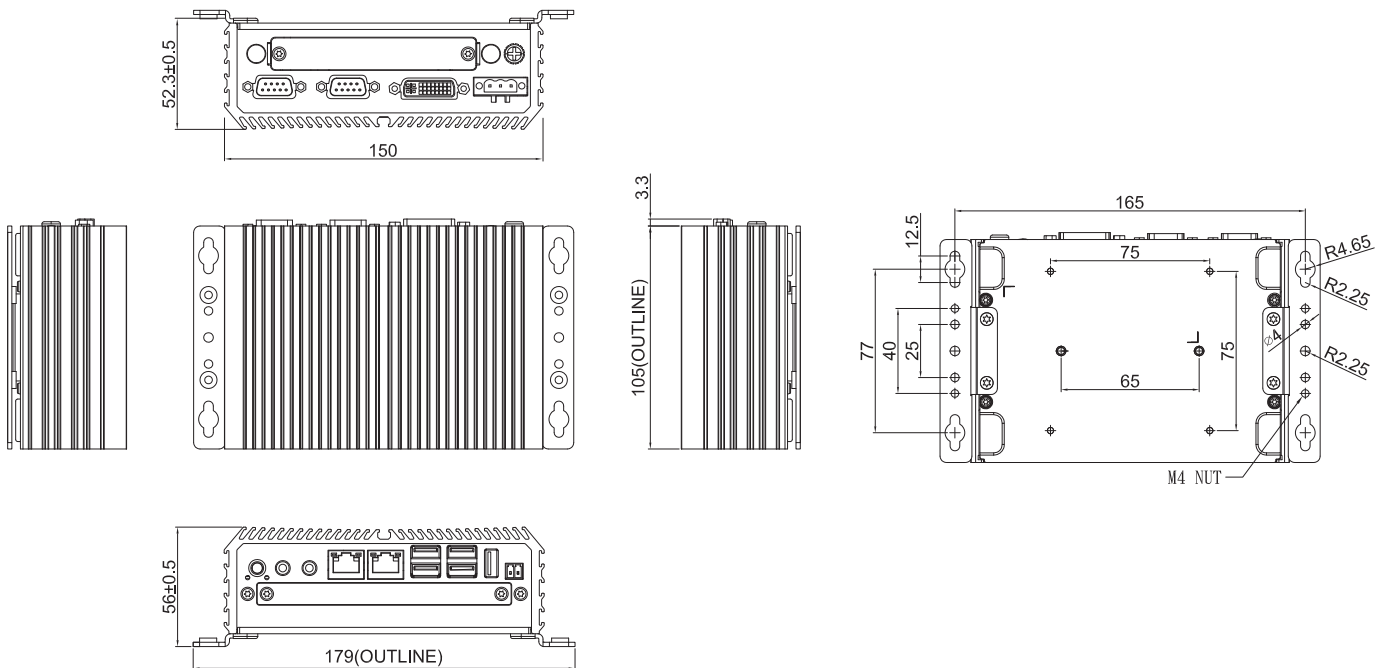

Unit: mm

Ordering Information

Available Models







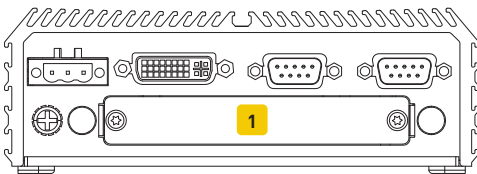

Model No.	Description
DA-1100-N42-R10	Intel® Pentium® Processor N4200 Affordable Fanless Embedded Computer
DA-1100-N33-R10	Intel® Celeron® Processor N3350 Affordable Fanless Embedded Computer

Package Checklist

• DA-1100 Affordable Fanless Embedded Computer	• Utility DVD Driver x 1
• Thermal Pad (for CPU Thermal Block) x 1	• DVI-I to VGA Adapter x 1
• Power Terminal Block Connector x 1	• Screw Pack x 1
• Remote Power On/Off Terminal Block Connector x 1	• Wall Mounting Kit x 1

Optional I/O Modules



Model No.	Description	1
 CMI-COM102/UB0403	CMI Module with 2x RS232/422/485, 1x Universal Bracket (96 x 15 mm)	V
 CMI-DIO100/UB0415	CMI Module with 8x Optical Isolated DIO (4 in/4 out), 1x Universal Bracket (96 x 15 mm)	V
 CMI-DP101/UB0406	CMI Module with 1x Display Port, 1x Universal Bracket (96 x 15 mm)	V
 CMI-DVI101/UB0407	CMI Module with 1x DVI-D Connector, 1x Universal Bracket (96 x 15 mm)	V
 CMI-LPPS102/UB0409	CMI Module with 1x LPT Port, 1x PS/2, 1x Universal Bracket (96 x 15 mm)	V
 CMI-VGA101/UB0416	CMI Module with 1x VGA Port, 1x Universal Bracket (96 x 15 mm)	V
 CMI-HD01/UB0408	CMI Module with 1x HDMI Port for DA Series, 1x Universal Bracket with HDMI Cutout for DA Series	V
 MEC-LAN-M102-15/UB0411	Mini-PCIe Module with 2x LAN Ports, 1x Universal Bracket (96 x 15 mm) * Only can be compatible with half slim SSD and mSATA when MEC-LAN is installed.	V

Optional Function Modules

Model No.	Description
CFM-PoE02	CFM Module with PoE Control Function, Individual Port 25.5W

Optional Accessories

Model No.	Description
SIDE02	Side Mount Kit for DA Series, with KMRH-K175 for DIN-Rail option
DINRAIL-R10	Diamond series DIN-RAIL Mount Kit
GST60A12-CIN1	Adapter AC/DC 12V 5A 60W, with 3pin Terminal Block Plug 5.0mm Pitch with Tubes, Level VI
GST120A24-CIN	Adapter AC/DC 24V 5A 120W, GST120A24-CIN, wide temp (-30°C ~ +70°C), level VI