

DI-1000

6th Generation Intel® Core™ Processor (Skylake-U) High Performance, Compact and Modular Rugged Embedded Computer



- Onboard 6th Generation Intel® Core™ Mobile Processor (BGA Type)
- 1x DDR4 SO-DIMM Socket, 2133MHz, Supports Up to 32 GB
- Triple Independent Display (DVI-I, DisplayPort)
- Compact Size 203 x 142 x 66.8 mm with Light Weight 1.65 kg
- 1x Hot-swappable 2.5" SATA HDD/SSD Bay and 1x Internal 2.5" SATA HDD/SSD Bay, Supports RAID 0/1
- Rich I/O Including DVI, DP, 2x GbE LAN, 6x COM, 6x USB, 8x Optical Isolated DIO
- Supports Cincoze CMI Technology for LAN, PoE & M12 Connector Expansion
- Supports Cincoze CFM Technology for Power Ignition Sensing (IGN) Function Expansion
- Cincoze MEC Module Kits for Various I/O Expansion
- 2x Full-size Mini-PCIe Slots for Wireless and I/O Expansion
- Wide Operating Temperature (-40°C to 70°C)
- E-Mark (E13, No.10R-0514273) Certified



Overview

Cincoze DI-1000 Series is a high-performance, compact and modular fanless embedded computer powered by 6th generation Intel® Core™ mobile processor (Skylake-U), it integrates Intel® HD graphic engine and accommodates one DDR4 socket up to 32 GB which allows DI-1000 Series to fulfill all kinds of high-end computing demands. Extremely compact size with dimension 203 x 142 x 66.8 mm, comprising unbeatable I/O such as DVI-I, DP, 2x LAN, 6x COM, 6x USB, 8x Optical Isolated DIO, PS/2, Mic-in, Line-out, and remote power on/off switch, supporting two full-size Mini-PCIe slots for wireless communication and I/O expansion, accommodating two 2.5" SATA HDD/SSD bay for RAID 0/1 function, making DI-1000 series unmatched in the market for its size and functions. DI-1000 Series weighs only 1.65 kg supporting 4 types of mounting mechanisms (Wall, DIN, Side and VESA) allowing it to be installed everywhere. The unique Cincoze's CMI (Combined Multiple I/O), CFM (Control Function Module) and MEC (Mini-PCIe Card) technologies allow DI-1000 Series to be expanded according to the specific needs. The options of ready-to-use modules including Multi-LAN, PoE, M12 connections, Power Ignition Sensing and various types of I/O interface, making DI-1000 series application-ready platform for factory automation, machine vision, in-vehicle, and mobile surveillance applications.

DI-1000 Series inherited the Rugged DNA design from Cincoze, featuring Fan-less design, cable-less design, wide operating temperature (-40~ 70°C), wide range DC input (9~48 VDC), high tolerance for shock and vibration, high standard electric protection, Long MTBF hours and integrated SuperCAP for CMOS battery maintenance-free. Those Rugged features making DI-1000 series suitable to be deployed in harsh and demanding environment.

Highlights

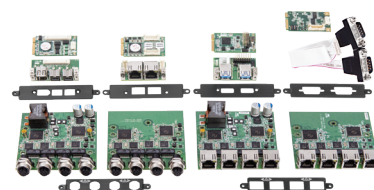

High Performance

- Onboard 6th Generation Intel® Core™ Mobile Processor
- Performance Enhanced by Intel® 14 nm Technology
- Extremely Low Power Consumption 15W TDP
- Intel® HD Graphics Supports Triple Independent Display Resolution Up to Ultra HD 4K

Compact Size

- Compact Size 203 x 142 x 66.8 mm with Light Weight 1.65 kg
- Rich I/O for Greater Device Connectivity (DVI, DisplayPort, 2x GbE LAN, 6x COM, 6x USB, 8x Optical Isolated DIO, PS/2)

Modular Design

- CMI (Combined Multiple I/O) Technology for LAN, PoE and M12 Connector Expansion
- CFM (Control Function Module) Technology for Power Ignition Sensing (IGN) Function Expansion
- Mini-PCIe Module Kits for Various I/O Expansion

Specifications

System

Processor

- On board Intel® Core™ i7-6600U Processor (4M Cache, up to 3.40 GHz, 15W TDP)
- Onboard Intel® Core™ i5-6300U Processor (3M Cache, up to 3.00 GHz, 15W TDP)
- Onboard Intel® Core™ i3-6100U Processor (3M Cache, 2.30 GHz, 15W TDP)

Chipset

- SoC

BIOS

- AMI 8Mbit SPI BIOS

Memory

- 1x DDR4 260-pin SO-DIMM Socket, Support up to 32 GB (2133MHz, Un-buffered and Non-ECC type)

Graphics

- Integrated Intel® HD Graphics
- Three Independent Display

Audio

- Realtek® ALC888-GR
- High Definition Audio

I/O Interface

- 1x DVI-I Connector, Resolution 1920 x 1080
- 1x DisplayPort Connector (4096 x 2304 @ 60Hz, According to CPU Specifications)
* Verified maximum resolution: 3840x2160.
- 2x GbE LAN (Support Wake-on-LAN, Teaming, Jumbo Frame, IEEE 1588v2 and PXE), RJ45
 - GbE1: Intel I210
 - GbE2: Intel I219-LM
- 6x RS-232/422/485 with Auto Flow Control (Support 5V/12V), DB9
- 4x USB 3.2 Gen1 (Type-A) & 2x USB 2.0 (Type-A)
- 1x PS/2, 6-Pin Mini-DIN Female Connector
- 8x Optical Isolated DIO (4x DI, 4x DO), 10-Pin Terminal Block Support 5~48V
- 1x Line-out, Phone Jack 3.5mm
- 1x Mic-in, Phone Jack 3.5mm
- 1x ATX Power On/Off Button
- 1x AT/ATX Mode Switch
- 1x Clear CMOS Switch
- 1x Remote Power On/Off Connector, 2-Pin Terminal Block

Storage

- 2x 2.5" SATA HDD/SSD Bay, Support RAID 0/1 (Gen3) (One Internal, One Front Accessible & Hot-swappable)
- 2x mSATA (shared by Mini-PCIe socket) (Gen3)

Expansion

- 1x CFM Interface for Cincoze CFM Modules
- 1x CMI Interface for Cincoze CMI Modules
- 2x Full-size Mini-PCIe Sockets for Wireless & I/O Expansion
- 1x SIM Socket

Other Function

- Support CFM (Control Function Module) Technology
- Support CMI (Combined Multiple I/O) Technology
- Support Instant Reboot Technology (0.2 sec)
- SuperCap Integrated for CMOS Battery Maintenance-free
- Watchdog Timer: Software Programmable Supports 256 Levels System Reset

Power Requirement

- Support AT/ATX Power Type
- Power Input Voltage 9~48VDC
- One 3-Pin Terminal Block Connector
- Optional Power Adapter AC/DC 12V/5A 60W or 24V/5A 120W

Physical

- Dimension (WxDxH): 203 x 142 x 66.8 mm
- Weight: 1.65 kg
- Extruded Aluminum with Heavy Duty Metal
- Support Wall / Side / DIN-RAIL / VESA Mounting
- Fanless Design
- Cable-less Design
- Unibody Chassis
- Jumper-less Design

Protection

- Reverse Power Input Protection
- Over Voltage Protection: Protection Range: 51~58V
Protection Type: shut down operating voltage, re-power on at the preset level to recover
- Over Current Protection: 15A
- ESD Protection: +/-8kV (air), +/-4kV (contact)
- Surge Protection: 2 kV

MTBF

- Time: 360,145 Hours
- Calculation Model: Telcordia SR-332 Issue 3, Method 1, Case 3
- Environment: GB, GC
- Temperature: 40°C

Operating System

- Windows® 10 / 8.1 / 7

Environment

- Operating Temperature: -40°C to 70°C (With extended temperature peripherals; Ambient with air flow; According to IEC60068-2-1, IEC60068-2-2, IEC60068-2-14)
- Storage Temperature: -40°C to 85°C
- Relative Humidity: 95% RH @ 70°C (Non-condensing)
- Shock: Operating, 50 Grms, Half-sine 11 ms Duration (w/ SSD, according to IEC60068-2-27)
- Vibration: Operating, 5 Grms, 5-500 Hz, 3 Axes (w/ SSD, according to IEC60068-2-64)
- EMC: CE, UKCA, FCC, ICES-003 Class A, EN50121-3-2 (Railway), E-Mark (E13, No. 10R-0514273)

External Layout

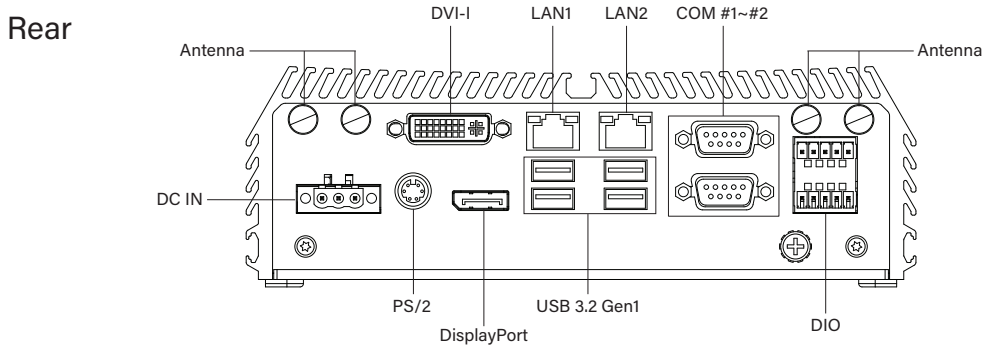
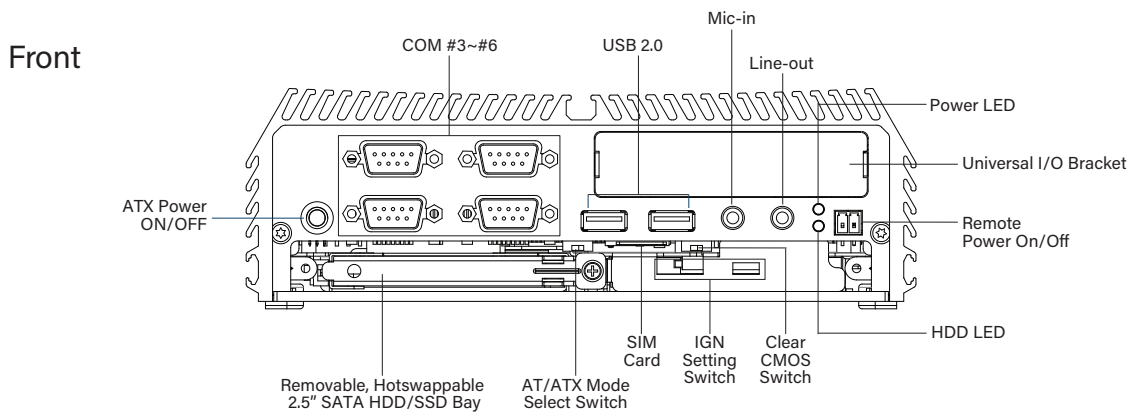

Dimensions

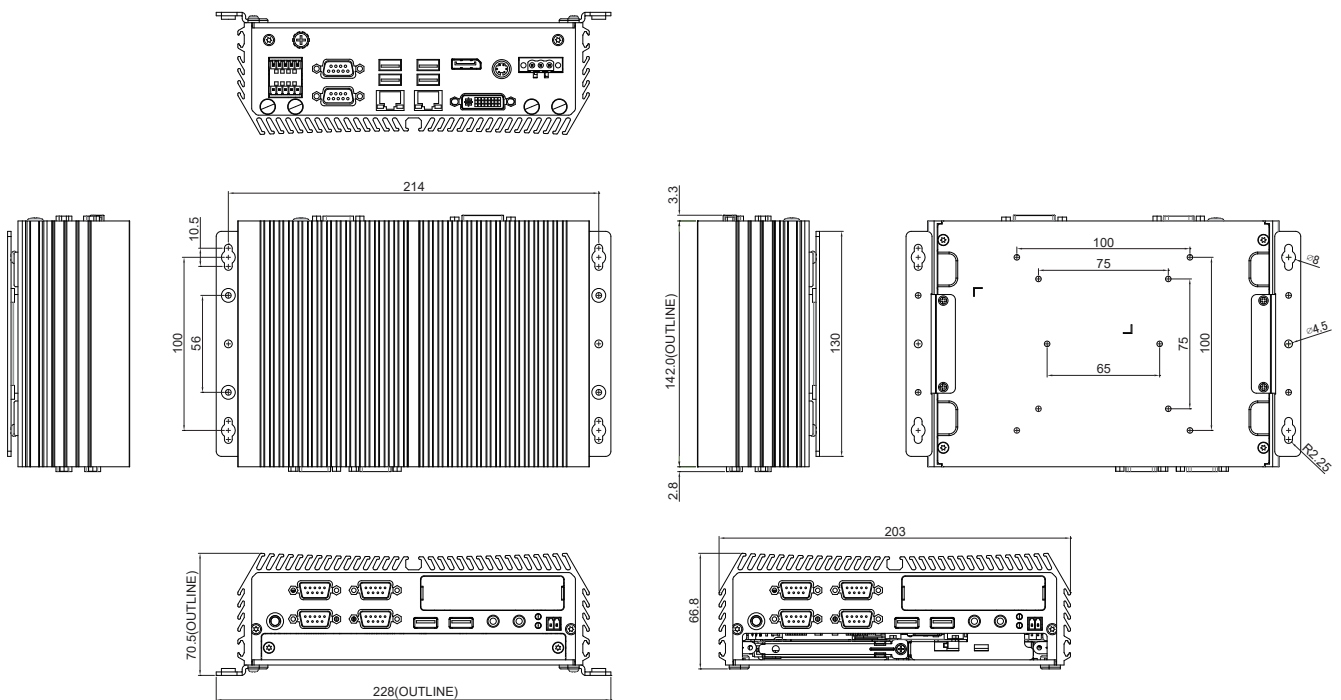

Unit: mm

Ordering Information

Available Models

Model No.	Description
DI-1000-i7-R11	6th Gen. Intel® Core™ i7-6600U High Performance, Compact and Modular Rugged Embedded Computer
DI-1000-i5-R11	6th Gen. Intel® Core™ i5-6300U High Performance, Compact and Modular Rugged Embedded Computer
DI-1000-i3-R11	6th Gen. Intel® Core™ i3-6100U High Performance, Compact and Modular Rugged Embedded Computer

Package Checklist





- DI-1000 Embedded System x 1
- CPU Heatsink Thermal Pad x1
- Utility DVD Driver x 1
- Screw Pack x 1
- Wall Mounting Kit x1
- Power Terminal Block Connector x 1
- Remote Power On/Off Terminal Block Connector x 1
- DIO Terminal Block Connector x 2
- DVI-I to VGA Adaptor

Optional Modules & Accessories

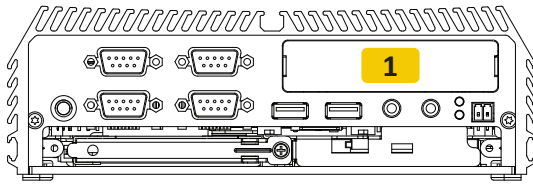
Model No.	Description
CFM-IGN102	CFM Module with Power Ignition Sensing Control Function, Selectable 12V/24V
CMI-LAN01-R12/UB0712	CMI Module with 4x Intel I210 GbE LAN, RJ45 Port / 1x Universal Bracket
CMI-M12LAN01-R12/UB0710	CMI Module with M12 Connector, 4x Intel I210 GbE LAN / 1x Universal Bracket
MEC-COM-M212-DB9/UB0703	Mini-PCIe Module with 2x COM Ports, 1x Standard DB9 Cable, 1x Universal Bracket with 2x DB9 Cutout for DI-1000
MEC-LAN-M102-15/UB0711	Mini-PCIe Module with 2x LAN Ports / 1x Universal Bracket
MEC-USB-M102-15/UB0714	Mini-PCIe Module with 2x USB 3.2 Gen1 Ports, 1x 15cm cable, 1x Universal Bracket with 2x USB Cutout for DI-1000
DIN01	DIN-RAIL Mount Kit, KMRH-K175
SIDE01	SIDE Mount Kit
GST60A12-CIN1	Adapter AC/DC 12V 5A 60W with 3pin Terminal Block Plug 5.0mm Pitch, with Tubes, Level VI
GST120A24-CIN	Adapter AC/DC 24V 5A 120W with 3pin Terminal Block Plug 5.0mm Pitch, with Tubes, Level VI

Optional Module Configuration



Model No.	Description	1
<p>CMI-LAN01-R12/UB0712</p> 	CMI Module with 4x Intel I210 GbE LAN, RJ45 Port / 1x Universal Bracket	V
<p>CMI-M12LAN01-R12/UB0710</p> 	CMI Module with M12 Connector, 4x Intel I210 GbE LAN / 1x Universal Bracket	V
<p>MEC-COM-M212-DB9/UB0703</p> 	Mini-PCIe Module with 2x COM Ports, 1x Standard DB9 Cable, 1x Universal Bracket with 2x DB9 Cutout for DI-1000	V
<p>MEC-LAN-M102-15/UB0711</p> 	Mini-PCIe Module with 2x LAN Ports / 1x Universal Bracket	V
<p>MEC-USB-M102-15/UB0714</p> 	Mini-PCIe Module with 2x USB 3.2 Gen1 Ports, 1x Universal Bracket, 1x Cable for MEC-USB	V