

GP-3000

Dual Full-length GPU Expandable Computer



- Supports 9th/8th Gen Intel® Xeon®/Core™ Processor (35W / 65W / 80W)
- 2 x DDR4 SO-DIMM Sockets, Supports ECC/non ECC type up to 2666 MHz, 64GB
- 4 x 2.5" Hot Swappable SATA III HDD/SSD Bays (Max Height 15 mm)
- 1 x M.2 M Key Socket (NVMe), 1 x M.2 E Key Socket (CNVi)
- 2 x Front Accessible SIM Card Slots for Signal Redundancy
- CMI Technology for Various I/O Module Expansions
- CFM Technology for Power Ignition Sensing & PoE Function
- Versatile Mounting Methods (Wall / Desktop / Face-up / 19" Rack Mount)
- Military Standard Shock & Vibration Proof



Overview

GP-3000. A flagship GPU edge computing computer of Cincoze. Its crowning feature is an exclusive GPU Expansion Box that provides expansion for up to two high-end GPU cards and creating a high-performance industrial-grade GPU computing computer.

Extreme Computing Performance

The GP-3000's extreme computing power starts with an 8th or 9th generation Intel® Xeon® or Core™ i3/i5/i7 (Coffee Lake and Coffee Lake-R) CPU, Intel® C246 chipset, and supports two sets of DDR4-2666 ECC/non-ECC SO-DIMM up to 128 GB and can support up to two 250 W high-end GPU cards. With a total power consumption of 720W, it's easy to meet and exceed high-efficiency application requirements. A precision heat dissipation and cooling design quickly wick away heat, keeping the focus squarely on the breathtaking performance of the GP-3000.

Rich Application Functions

The GP-3000 redefines the standard for high-end GPU computers, with high-speed I/O and multiple functions. In addition to the standard five LAN ports and six USB 3.2 ports, the GP-3000 uses Cincoze's exclusive CMI and CFM modular design, which offers expansion modules with eight Gigabit PoE, two USB 3.2, or dual 10 Gb/s LAN ports. Storage options include high-speed M.2 NVMe storage slots and four hot-swappable 2.5" HDD/SSD trays accessible through the front maintenance panel. Together, they meet large-capacity machine vision storage requirements and improve hard disk accessibility for convenient removal and replacement. The IGN module (power ignition sensing) can monitor the on-board battery voltage and set a delayed shutdown time to avoid damage to the system due to unstable current when starting or turning off the engine. This combination of diverse functions provides the flexibility to meet the requirements of different market applications.

Strong and Reliable

In the pursuit of ever-higher standards, the GP-3000 has passed the MIL-STD-810G certification designed and promulgated by the US Department of Defense to qualify military equipment. The GP-3000 features 9~48 VDC power input, is built for -40 to 70°C temperature operation. The GP-3000 has E-mark and EN50155 (EN50121-3-2 only) certifications, so it is capable of withstanding the rigors of rail and vehicle applications as well as other harsh environments.

Highlights



Cutting-Edge Performance

The GP-3000 is powered by the excellent performance of 8th / 9th generation Intel® Xeon® / Core™ processors. Supports two DDR4 SO-DIMM ECC/Non-ECC memory, up to 128GB. Through the exclusive GPU Expansion Box (GEB) design can flexibly expand up to dual high-end GPU cards. And GP-3000 offers 720W system power budget for high-end GPU Computing applications.



Futureproof Scalability

Upgrades are now easy. In addition to GPU expansion through the GEBs, the GP-3000 also retains flexibility for future upgrades. Whether adding or upgrading GPU cards, the core system remains, and only the GEB is changed. Upgrades become easier, and the expansion possibilities become almost endless.



Mount Anywhere

The GP-3000 supports multiple mounting options for various environment. Mounting options include a wall mount, desktop mount, Face-up mount, and 19" rack mount. Simple.

Specifications

Processor

- 9th Generation Intel Coffee Lake-R S Series CPU:
 - Intel® Xeon® E-2278GE 8 Cores Up to 4.7 GHz, TDP 80W
 - Intel® Xeon® E-2278GEL 8 Cores Up to 3.9 GHz, TDP 35W
 - Intel® Core™ i7-9700E 8 Cores Up to 4.4 GHz, TDP 65W
 - Intel® Core™ i5-9500E 6 Cores Up to 4.2 GHz, TDP 65W
 - Intel® Core™ i3-9100E 4 Cores Up to 3.7 GHz, TDP 65W
 - Intel® Core™ i7-9700TE 8 Cores Up to 3.8 GHz, TDP 35W
 - Intel® Core™ i5-9500TE 6 Cores Up to 3.6 GHz, TDP 35W
 - Intel® Core™ i3-9100TE 4 Cores Up to 3.2 GHz, TDP 35W
- 8th Generation Intel Coffee Lake S Series CPU:
 - Intel® Xeon® E-2176G 6 Cores up to 4.7 GHz, TDP 80W
 - Intel® Xeon® E-2124G 4 Cores up to 4.5 GHz, TDP 71W
 - Intel® Core™ i7-8700 6 Cores up to 4.6 GHz, TDP 65W
 - Intel® Core™ i5-8500 6 Cores, up to 4.1 GHz, TDP 65W
 - Intel® Core™ i3-8100 4 Cores 3.6 GHz, TDP 65W
 - Intel® Core™ i7-8700T 6 Cores up to 4.0 GHz, TDP 35W
 - Intel® Core™ i5-8500T 6 Cores up to 3.5 GHz, TDP 35W
 - Intel® Core™ i3-8100T 4 Cores 3.1 GHz, TDP 35W
 - Intel® Pentium® G5400 2 Cores 3.7 GHz, TDP 58W
 - Intel® Pentium® G5400T 2 Cores 3.1 GHz, TDP 35W
 - Intel® Celeron® G4900 2 Cores 3.1 GHz, TDP 54W
 - Intel® Celeron® G4900T 2 Cores 2.9 GHz, TDP 35W

Chipset

- Intel® C246

Memory

- 2x DDR4 2666/2400 MHz SO-DIMM Sockets
 - * Xeon/i7/i5: Up to DDR4 2666MHz
 - * i3/Pentium/Celeron: Up to DDR4 2400MHz
- Supports ECC / non-ECC Type Up to 64GB

Graphics

- Integrated Intel® UHD Graphics
 - (Xeon/i7/i5/i3: UHD 630; Pentium/Celeron: UHD 610)
- Supports Triple Independent Display (VGA/DisplayPort/HDMI)

Audio

- Realtek® ALC888, High Definition Audio

BIOS

- AMI BIOS

I/O Interface

- 1x HDMI Connector (4096 x 2160 @30Hz)
- 1x DisplayPort Connector
 - (4096 x 2304 @ 60Hz, According to CPU Specifications)
 - * Verified maximum resolution: 3840x2160
- 1x VGA Connector (1920 x 1200 @30Hz)
- 5x GbE LAN, RJ45
 - GbE1: Intel® I219-LM
 - GbE2: Intel® I210
 - GbE3: Intel® I210
 - GbE4: Intel® I210
 - GbE5: Intel® I210
- 2x RS-232/422/485 with Auto Flow Control (Supports 5V/12V), DB9

- 2x 10Gbps USB 3.2 Gen2, Type A
- 4x 5Gbps USB 3.2 Gen1, Type A
- 1x Line-out, Phone Jack 3.5mm
- 1x Mic-in, Phone Jack 3.5mm
- 1x ATX Power On/Off Button
- 1x Remote Power On/Off, 2-pin Terminal Block
- 1x Remote Reset, 2-pin Terminal Block
- 1x AT/ATX Mode Switch
- 1x Reset Button
- 1x Clear CMOS Switch

Storage

- 4x 2.5" Front Accessible SATA HDD/SSD Bay (SATA 3.0), Supports Up to 15mm in Height
- 1x M.2 Key M 2280 Socket, Supports PCIe x4 NVMe SSD or SATA SSD (Gen3)
- Supports RAID 0 / 1 / 5 / 10

Expansion

- PCIe
 - Optional GPU Expansion Box
 - 1x PCIe x 4 + 1x PCIe x 16
 - 2x PCIe x 16 (8 Lanes) + 1x PCIe x 1 + 1x PCIe x 4
 - * Please See "Chapter 3 – GPU Expansion Box Specification" for more information.
- 2x Full-size Mini-PCIe Socket
- 1x M.2 Key E 2230 Socket, Supports Intel CNVi Module
- 1x M.2 Key M 2280 Socket, Support NVMe/SATA SSD
- 1x Universal Bracket
- 2x SIM Socket
- 7x Antenna Holes

Cincoze Modular Technology

- CMI Interface
 - 1x High Speed CMI (Combined Multiple I/O) Interface
 - 1x Low Speed CMI (Combined Multiple I/O) Interface
- CMI Module
 - Optional Modules:
 - 4x GbE LAN, RJ45
 - 4x GbE LAN, M12 A-Coded
 - 4x GbE LAN, M12 X-Coded
 - 2x 10GbE LAN, RJ45
 - 2x RS-232/422/485 with Auto Flow Control (Supports 5V/12V), DB9
 - 16x Optical Isolated DIO(8DI, 8DO), 2x 10 Pin Terminal Block
- CFM Interface
 - 1x CFM(Control Function Module) IGN Interface
 - 1x CFM(Control Function Module) PoE Interface
- CFM Module
 - Optional Module
 - 1x Power Ignition Sensing Module with Delay Time Management and Selectable 12V/24V
 - 1x PoE Function Module Supports Up to 4x PoE+ with Individual port 25.5W
- MEC Module
 - Optional Modules:
 - 2x 5Gbps USB 3.2 Gen1, Type A
 - 2x GbE LAN, RJ45

Other

- 2x Fan Kits (Air-flow isolated from the electronics)
- Support 0.2 sec Instant Reboot Technology
- SuperCap Integrated for CMOS Battery Maintenance-free Operation
- Watchdog Timer: Software Programmable Supports 256 Levels System Reset

Power Requirement

- Supports AT/ATX Power Type
- Power Input Voltage: 9-48 VDC, Single Power Source
- Total Power Budget: 720W (with GEB-3601-R10)
- Connector Type: 2x 3-pin Terminal Block, Each Terminal Block Current Limitation is 15A
- Power Supply:
 - Optional AC/DC or DC/DC 24V 480W Power Supply
 - Optional AC/DC or DC/DC 24V 1000W Power Supply

Physical

- Dimension (WxDxH): 105 x 195 x 370 mm
- Weight: 8 kg
- Extruded Aluminum with Heavy Duty Metal
- Wall Mount / Desktop Mount / 19" Rack Mount / Face-up Mount
- Unibody Chassis
- Jumper-less Design

Protection

- Reverse Power Input Protection
- Over Voltage Protection
 - Protection Range: 51~58V
 - Protection Type: shut down operating voltage, re-power on at the preset level to recover
- Over Current Protection: 30A
- ESD Protection: +/-8kV (air), +/-4kV (contact)
- Surge Protection: 2 kV

Operating System

- Windows® 10
- Linux: Supports by Project

Environment

- Operating Temperature:

CPU \ GPU	GPU	Non-GPU	1 x 250W GPU	1 x 350W GPU	2 x 250W GPU
35W		-40°C to 70°C	-40°C to 40°C	-40°C to 35°C	-40°C to 35°C
65W		-40°C to 60°C	-40°C to 40°C	-40°C to 35°C	-40°C to 35°C
80W		-40°C to 50°C	-40°C to 40°C	-40°C to 35°C	-40°C to 35°C

* With extended temperature peripherals; Ambient with air flow

* According to IEC60068-2-1, IEC60068-2-2, IEC60068-2-14

* 100% CPU and GPU without thermal throttling

- Storage Temperature: -40°C to 85°C
- Relative Humidity: 95% RH @ 70°C (Non-condensing)
- Shock: MIL-STD-810G
- Vibration: MIL-STD-810G
- EMC: CE, UKCA, FCC, ICES-003 Class A, EN50121-3-2 (Railway), E-mark
- Safety: LVD IEC/EN 62368-1
- MTBF: 441,283hr
- Fire Protection: EN 45545-2

External Layout

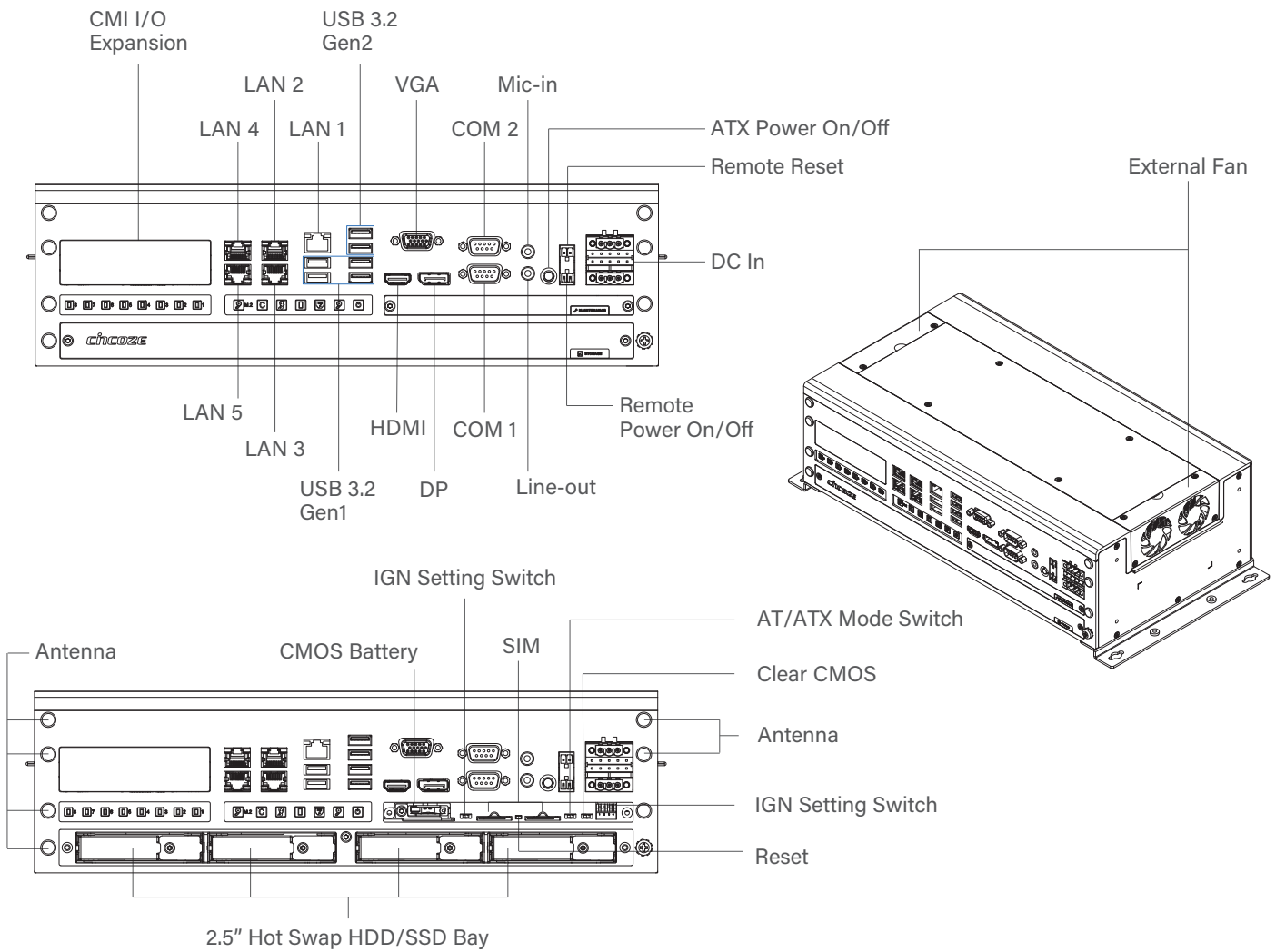

Dimensions

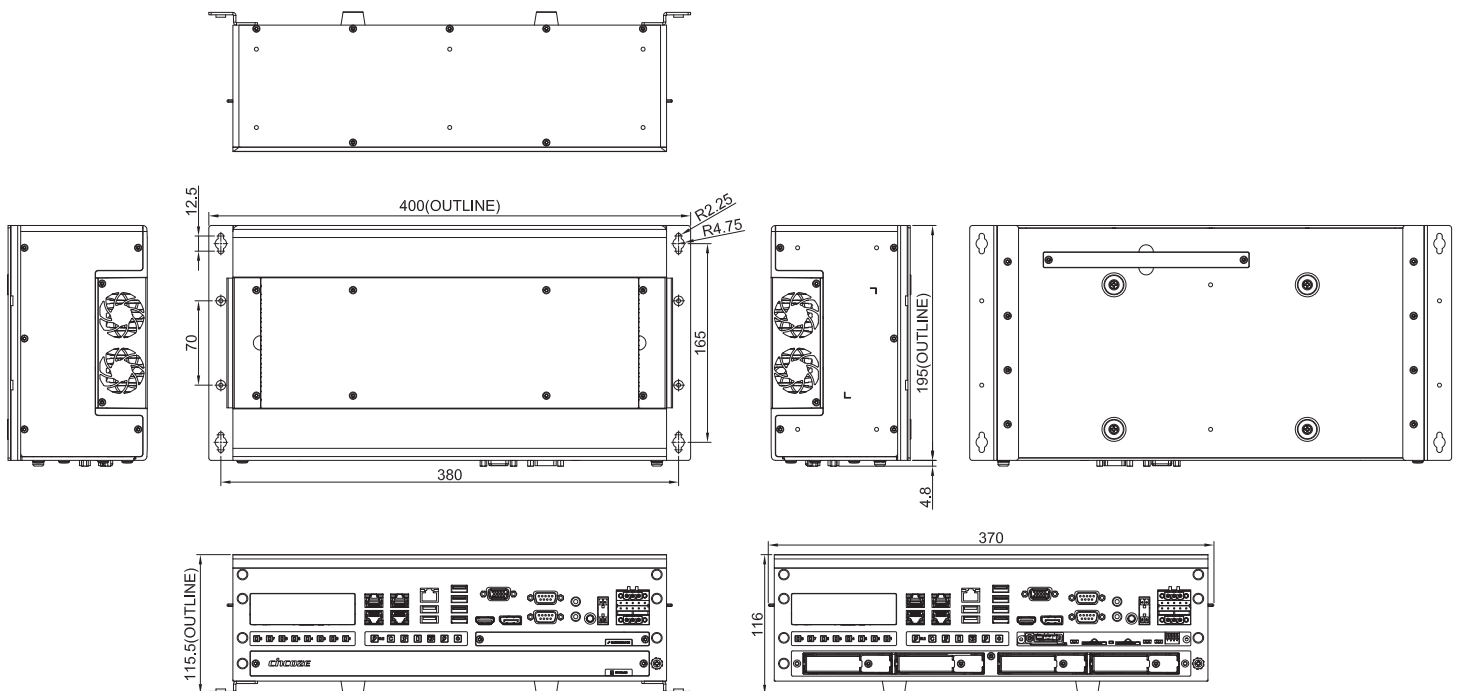

Unit: mm

Ordering Information

Available Models

GP-3000-R10



9th/8th Gen Intel® Xeon®/Core™ GPU Computer,
Supports Dual Full-length GPU Expansion Up to 500W

Package Checklist



Wall Mount Bracket



1 x Desktop Mount Kit



CPU Heatsink and Thermal Pad Kit



4 x Screw Pack



1 x Rubber Foot Kit



2 x Power Terminal Block Connector



2 x Remote Function Terminal Block Connector

Optional Module

GPU Expansion Box

GEB-3301-R10



GPU Expansion Box with 1x PCIe x16 and 1x PCIe x4 Slots for GP-3000 Series

GEB-3601-R10



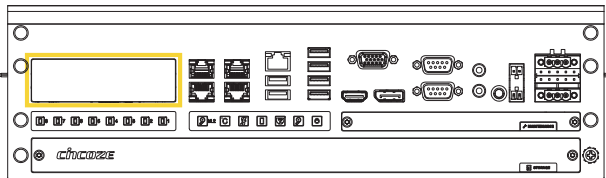

GPU Expansion Box with 2x PCIe x 16 (Signal PCIe x 8), 1x PCIe x 4 and 1x PCIe x 1 Slots for GP-3000 Series

Accessories - I/O Module



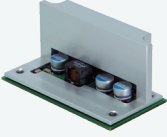
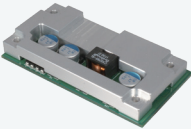

Model No.	Description
<p>CMI-LAN01-R12/UB1412</p>	<p>CMI Module with 4x Intel I210 GbE LAN, RJ45 Port / 1x Universal Bracket with 4x RJ45 Cutout for GP-3000 Series</p>
<p>CMI-M12LAN01-R12/UB1410</p>	<p>CMI Module with M12 A-Coded Connector, 4x Intel I210 GbE LAN / 1x Universal Bracket with 4x M12 Cutout for GP-3000 Series</p>
<p>CMI-XM12LAN01-R10/UB1410</p>	<p>CMI Module with M12 X-Coded Connector, 4x Intel I210 GbE LAN Ports / Universal Bracket with 4x M12 Cutout for GP-3000 Series</p>
<p>CMI-10GLAN02-R10/UB1428</p>	<p>CMI Module with 2x Intel X550 10GbE LAN, RJ45 Port / 1x Universal Bracket with 2x RJ45 Cutout for GP-3000 Series</p>
<p>CMI-COM04-R10/UB1403</p>	<p>CMI Module with 2x RS232/422/485 Ports (Support 5V/12V) / 1x Universal Bracket with 2x DB9 Cutout for GP-3000 Series</p>
<p>CMI-DIO04-R11/UB1418</p>	<p>CMI Module with 16DIO (8in 8out) / 1x Universal Bracket with DIO Cutout for GP-3000 Series</p>
<p>MEC-USB-M102-15/UB1414</p>	<p>Mini-PCIe Module with 2x USB 3.2 Gen1 Ports, 1x 15cm cable / 1x Universal Bracket with 2x USB Cutout for GP-3000 Series</p>





Accessories - Function Module

<p>CFM-PoE07-R10</p> 	<p>CFM Module with PoE Function, Individual Port 25.5W (Enable PoE function for CMI-LAN01-R12, CMI-M12LAN01-R12, CMI-XM12LAN01-R10)</p>
<p>CFM-PoE01</p> 	<p>CFM Module with PoE Function, Individual Port 25.5W (Enable PoE function for onboard LAN 2 to LAN 5)</p>
<p>CFM-IGN03-R10</p> 	<p>CFM Module with Power Ignition Sensing Function, 12V/24V Selectable</p>

Mounting Kit

<p>RM01-R10</p> 	<p>19" Rack Mount Kit for GP-3000</p>
<p>RM02-R10</p> 	<p>19" Rack Mount Kit for GP-3000/GEB-33 Series</p>
<p>RM03-R10</p> 	<p>19" Rack Mount Kit for GP-3000/GEB-36 Series</p>

Power Supply / Power Cord / Power Cable

<p>SDR-480-24</p> 	<p>DIN Rail Power Supply 480W 24V, SDR-480-24</p>
<p>HEP-1000-24</p> 	<p>Power Supply 1000W 24V, HEP-1000-24</p>
<p>US Power Cord</p> 	<p>1.8M US Power Cord, Stripped and Tinned End with Tube</p>
<p>EU Power Cord</p> 	<p>1.8M EU Power Cord, Stripped and Tinned End with Tube</p>
<p>Power Cable</p> 	<p>1M Power Cable with 3-Pin Terminal Block Plug, Stripped and Tinned End with Tube</p>